



DISCOVER THE ENGLISH VERSION HERE



Un lieu secret hors du temps et des sentiers battus!

Un pavillon de lumière accueillant jusqu'à 200 convives
au cœur d'un parc naturel préservé de 3 hectares.

Un espace discret, élégant et entièrement modulable,
pour un mariage authentique à votre identité.

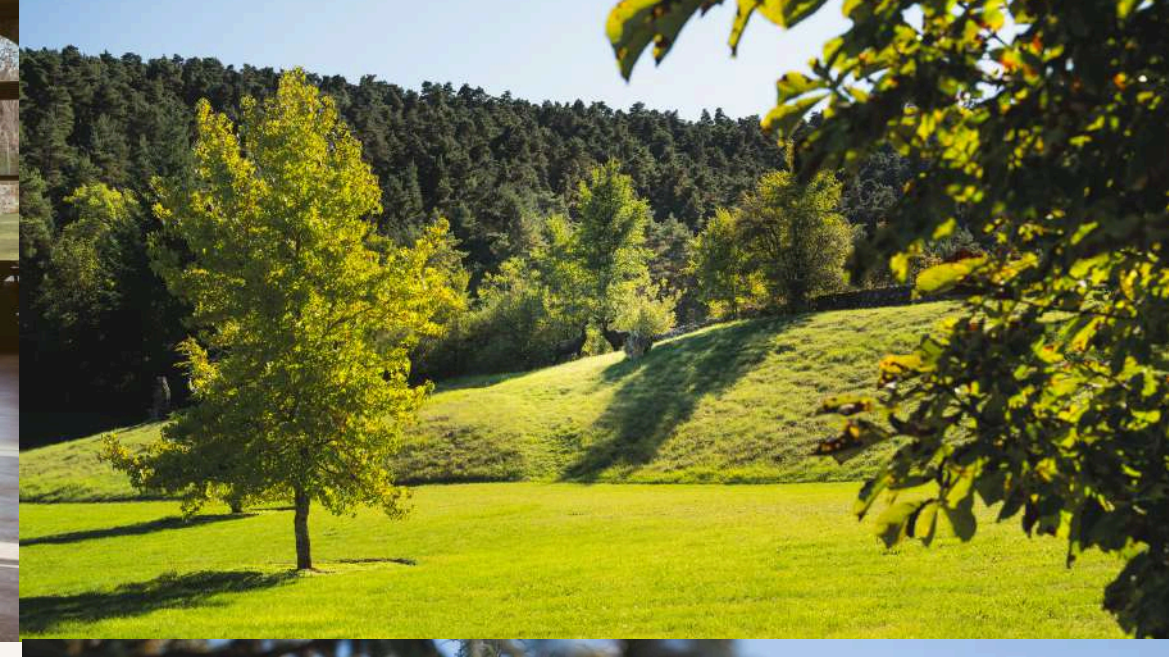
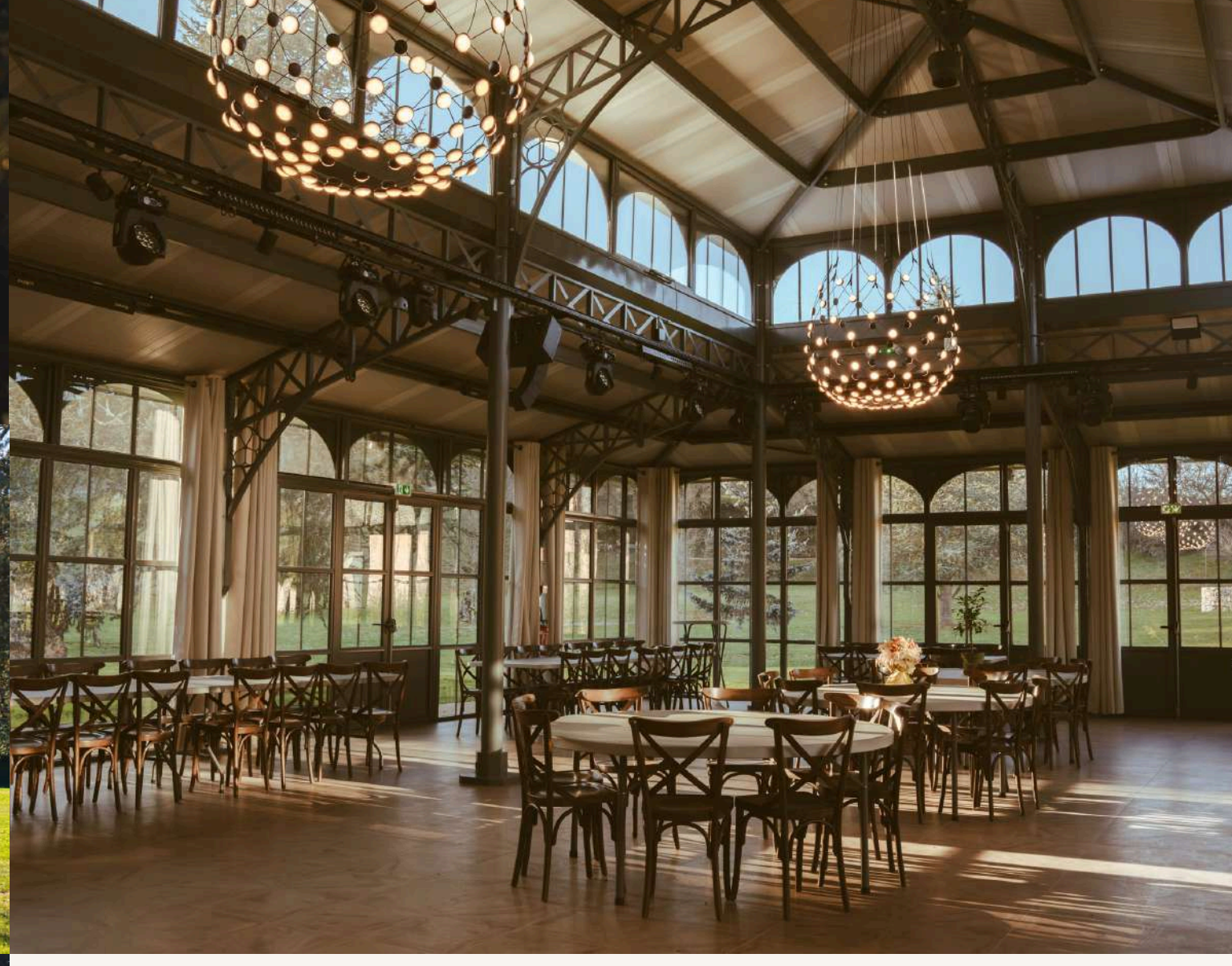

L'ORANGERIE DE *Romy*



Ici, chaque union trouve son propre souffle.
Pas de décor figé, mais un lieu habité,
ouvert à vos envies et à votre histoire.

- . Au cœur d'un parc naturel d'exception de 3 hectares
- . Capacité en réception jusqu'à 200 convives
- . Espace traiteur intégré, fonctionnel et discret
- . Mobilier modulable*, micros, écran et vidéoprojecteur
- . Plancher chauffant ou rafraichissant
- . Système de sonorisation et d'éclairage professionnel

Quelle que soit la saison, L'Orangerie de Romy
vous accueille pour célébrer la vie dans le sud en Occitanie,
en toute liberté, et profiter pleinement de chaque instant.

*Liste disponible ci-dessous



HAUTE SAISON

De juin à septembre

2 nuits à partir de 17 000€*
(3 nuits à partir de 19 500€*)

EXPERIENCES SIGNATURE
en supplément et sous réservation



BASSE SAISON

De novembre à mi-décembre et mars

2 nuits à partir de 13 000€*
(3 nuits à partir de 14 900€*)

EXPERIENCES SIGNATURE
en supplément et sous réservation

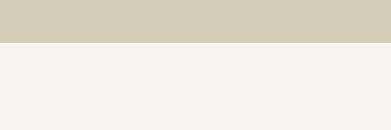

MOYENNE SAISON

Avril, mai et octobre

2 nuits à partir de 15 000€*
(3 nuits à partir de 17 500€*)

EXPERIENCES SIGNATURE
en supplément et sous réservation



CONDITIONS GÉNÉRALES

VOTRE MARIAGE

à L'Orangerie de Romy

TARIFS 2026 TTC

. Nos tarifs incluent la location de L'Orangerie de Romy ainsi que les
espace extérieurs, un mobilier modulable et l'hébergement au
domaine de La Vialette pour 30 couchages.

. Les tarifs sont susceptibles de modification sans préavis.

L'ORANGERIE DE ROMY

. Disponible pour le montage la veille de votre réception à partir de
10hrs et jusqu'au lendemain à 16hrs au plus tard.

CONDITIONS DE RESERVATION

. Acompte de 30% sur le montant total du devis pour réserver

. 30% trois mois avant la date de votre mariage

. 40% à régler un mois avant la date de votre mariage

. Les acomptes versés ne sont pas remboursables

VOTRE HÉBERGEMENT

Au Domaine de La Vialette

TARIFS

. Nos tarifs incluent le petit déjeuner à la française, Wi-Fi, accès à
notre espace bien-être et parking avec borne de recharge.

ARRIVÉE

. Nous vous attendons au domaine à partir de 16h00.

DÉPART

. Les chambres doivent être libérées à 12h00 au plus tard.

EXPERIENCES SIGNATURE

. En supplément et sous réservation anticipée

. Nous vous invitons à les découvrir ci-dessous dans la brochure

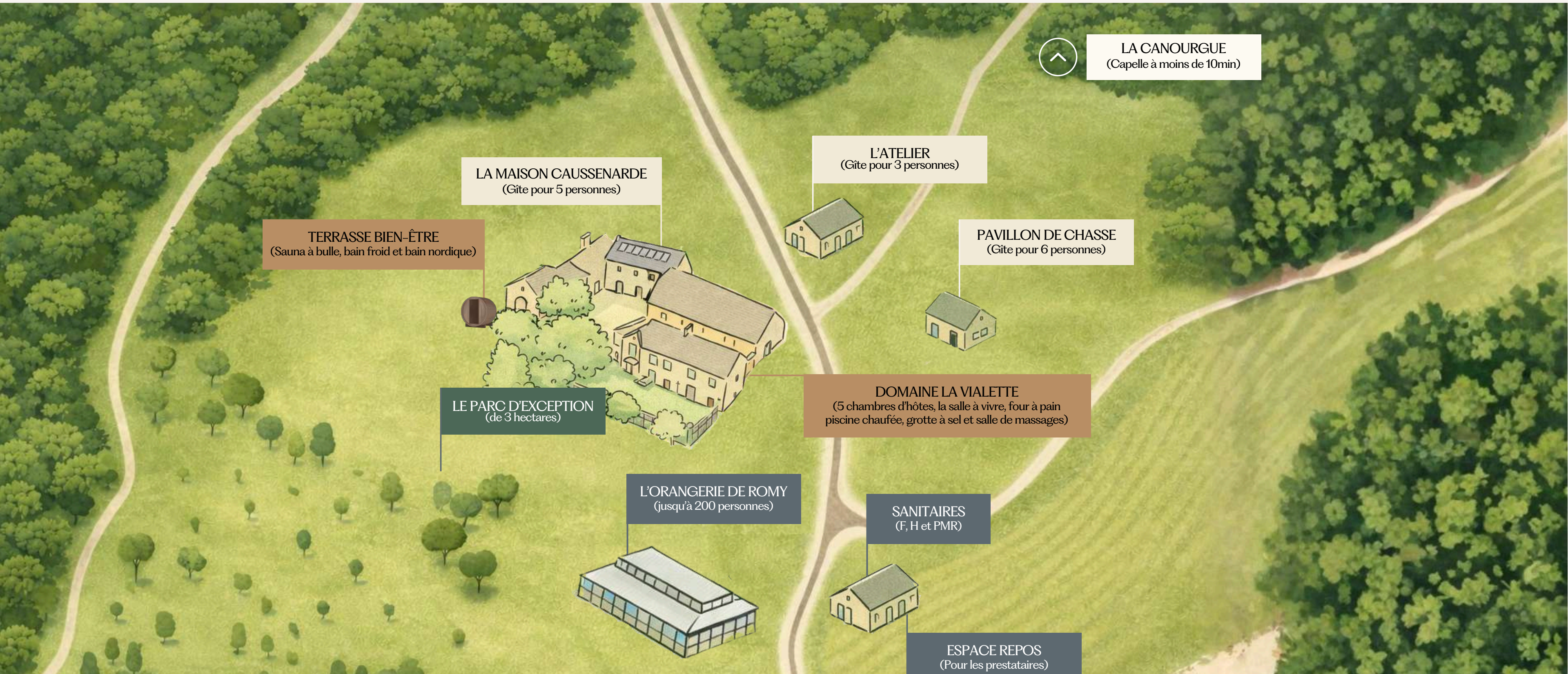

L'ORANGERIE DE *Romy*

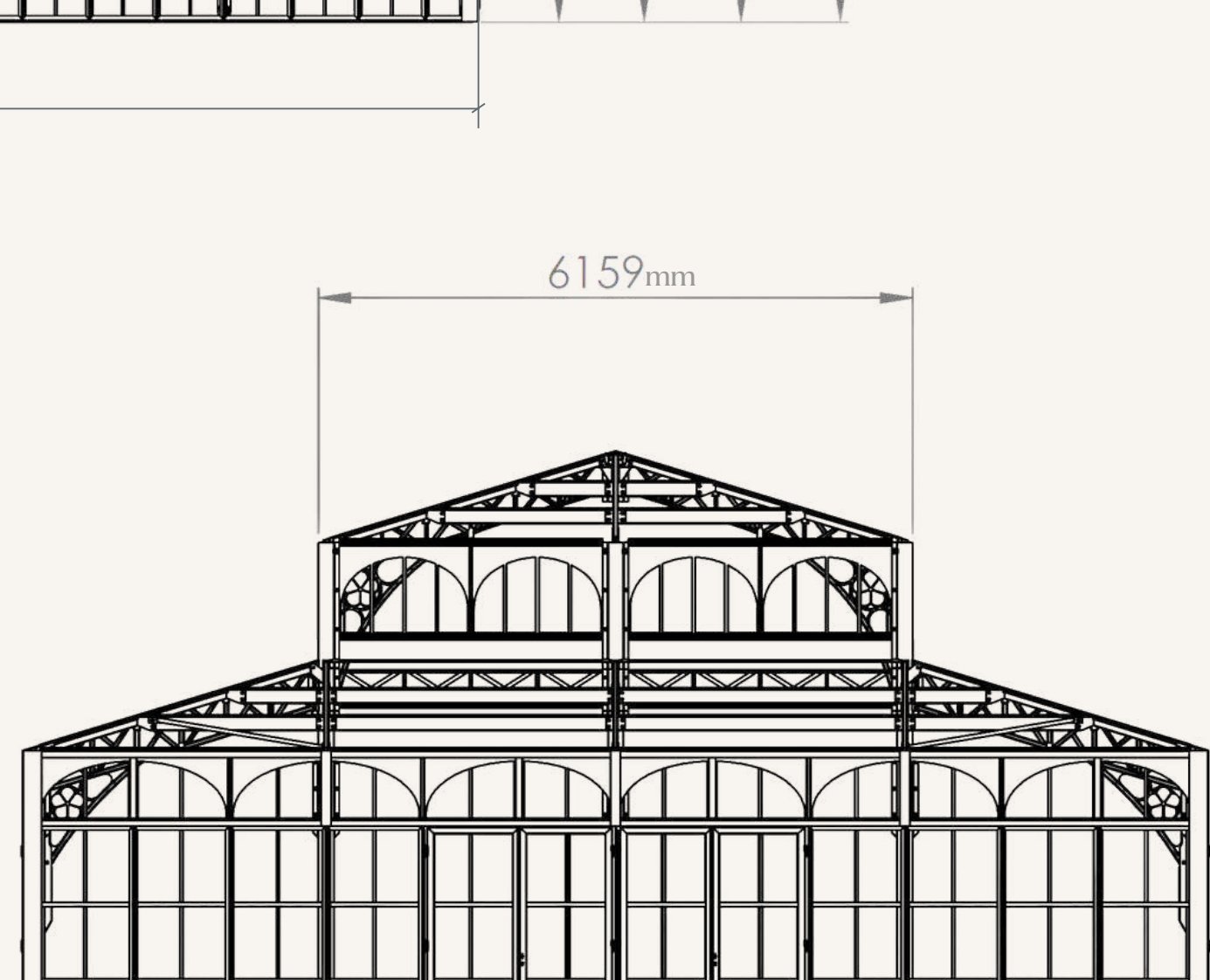
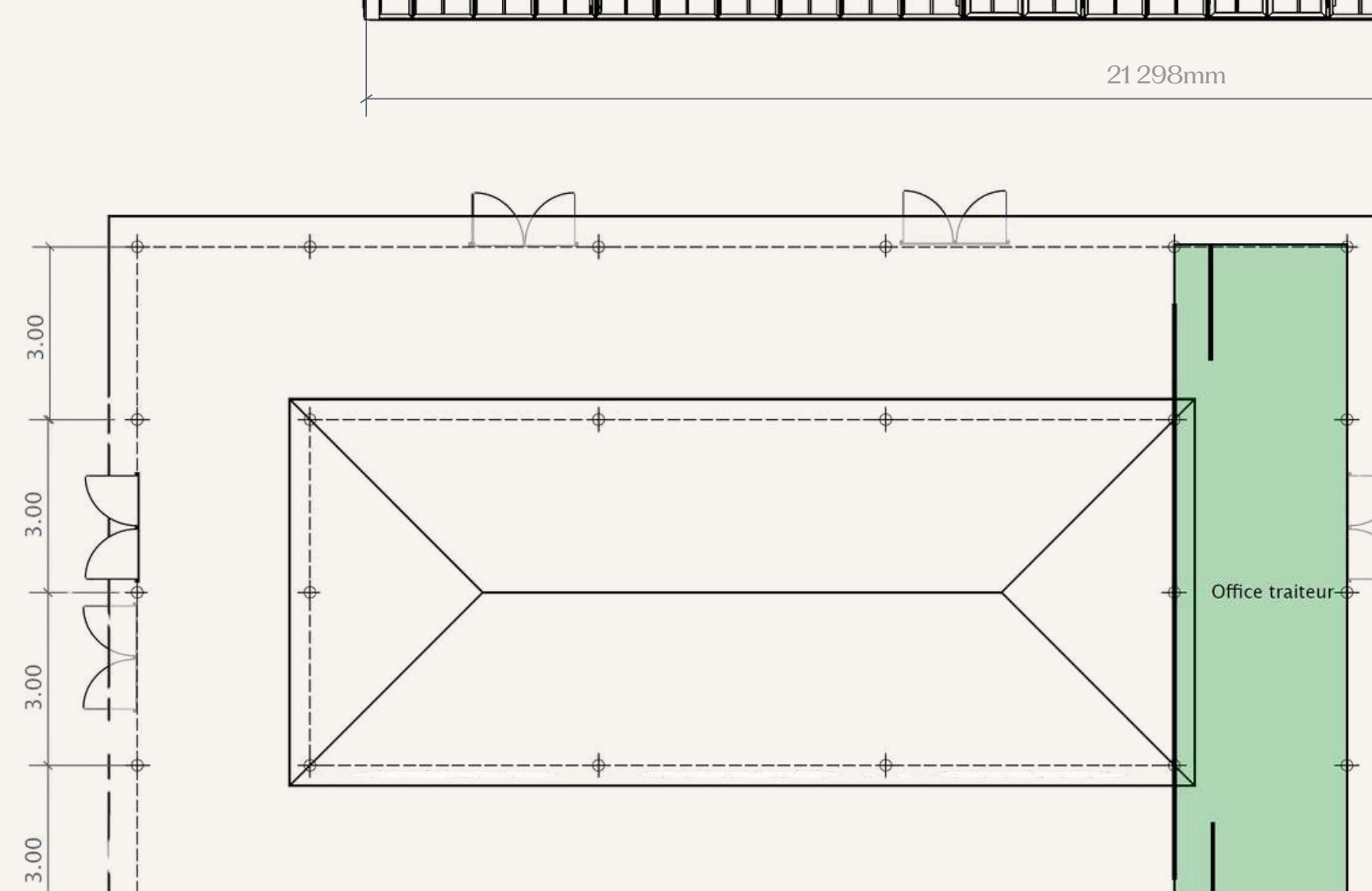
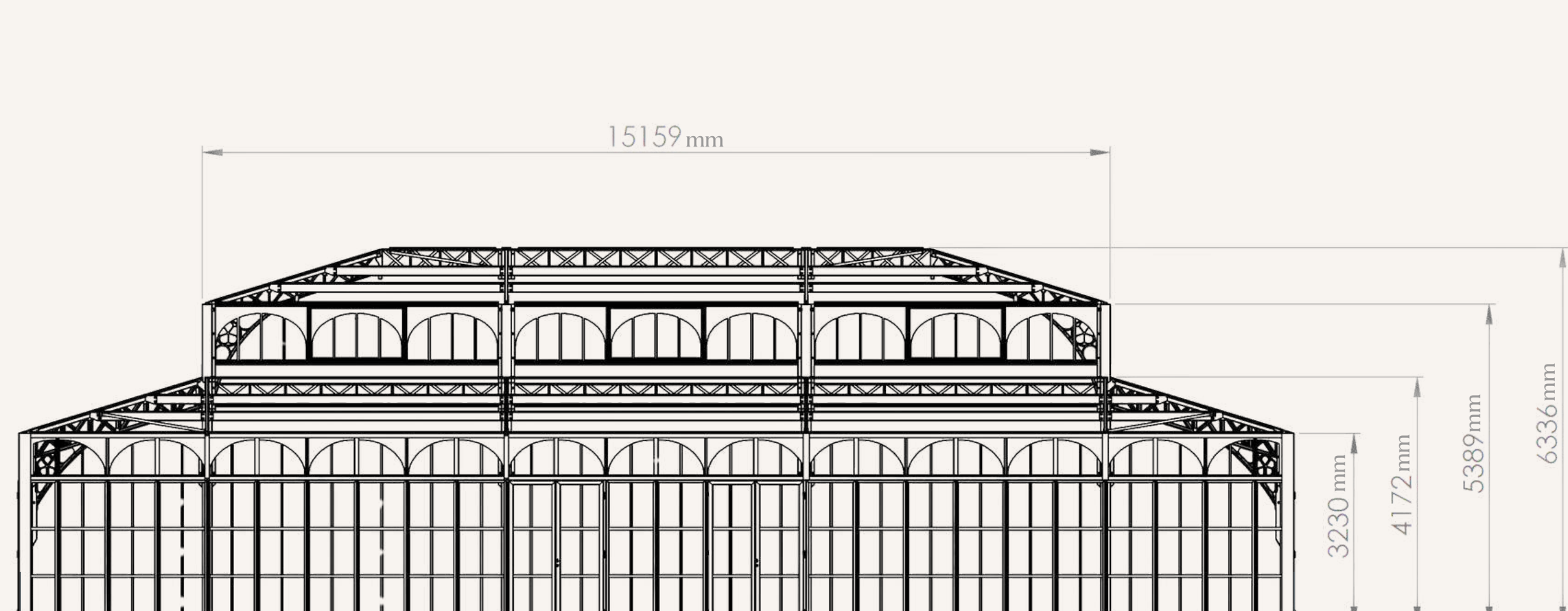

MOBILIER MODULABLE

inclus dans la location



160 CHAIRES CROSS
en bois hêtre



10 TABLES RONDES
Pour 8 personnes de 180cm

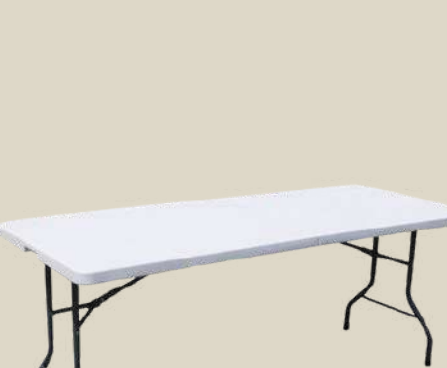

20 TABLES RECTANGULAIRES
Entre 8 à 10 personnes de 180x90cm



08 MANGE-DEBOUTS
de 80cm de diamètre

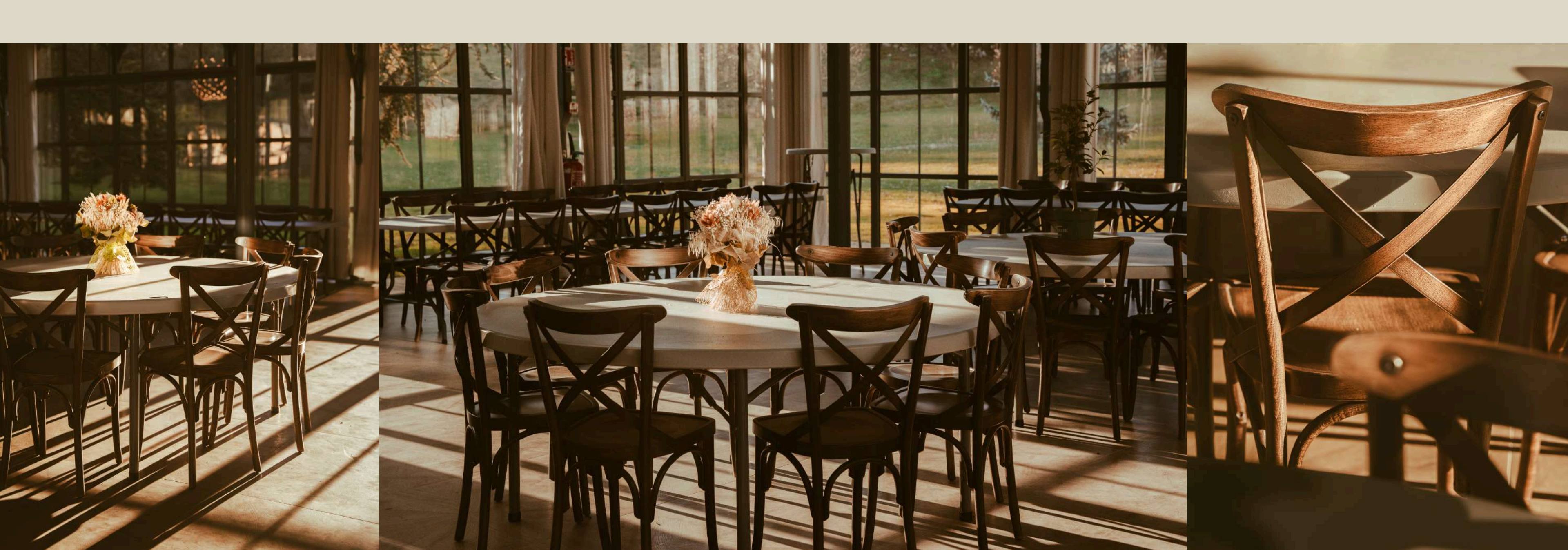

Votre hébergement en plein coeur d'une nature d'exception



DOMAINE
DE LA *Vialette*



Ecogîte chaleureux en Occitanie,
au coeur d'une nature d'exception.

Plus qu'un lieu d'accueil :
c'est un lieu de mémoire!

Depuis 42 ans, cette ancienne ferme
caussenarde du XIVe accueille des
voyageurs en quête de calme, de
nature, de sincérité.



30 COUCHAGES



ESPACE BIEN-ÊTRE



TABLE D'HÔTES

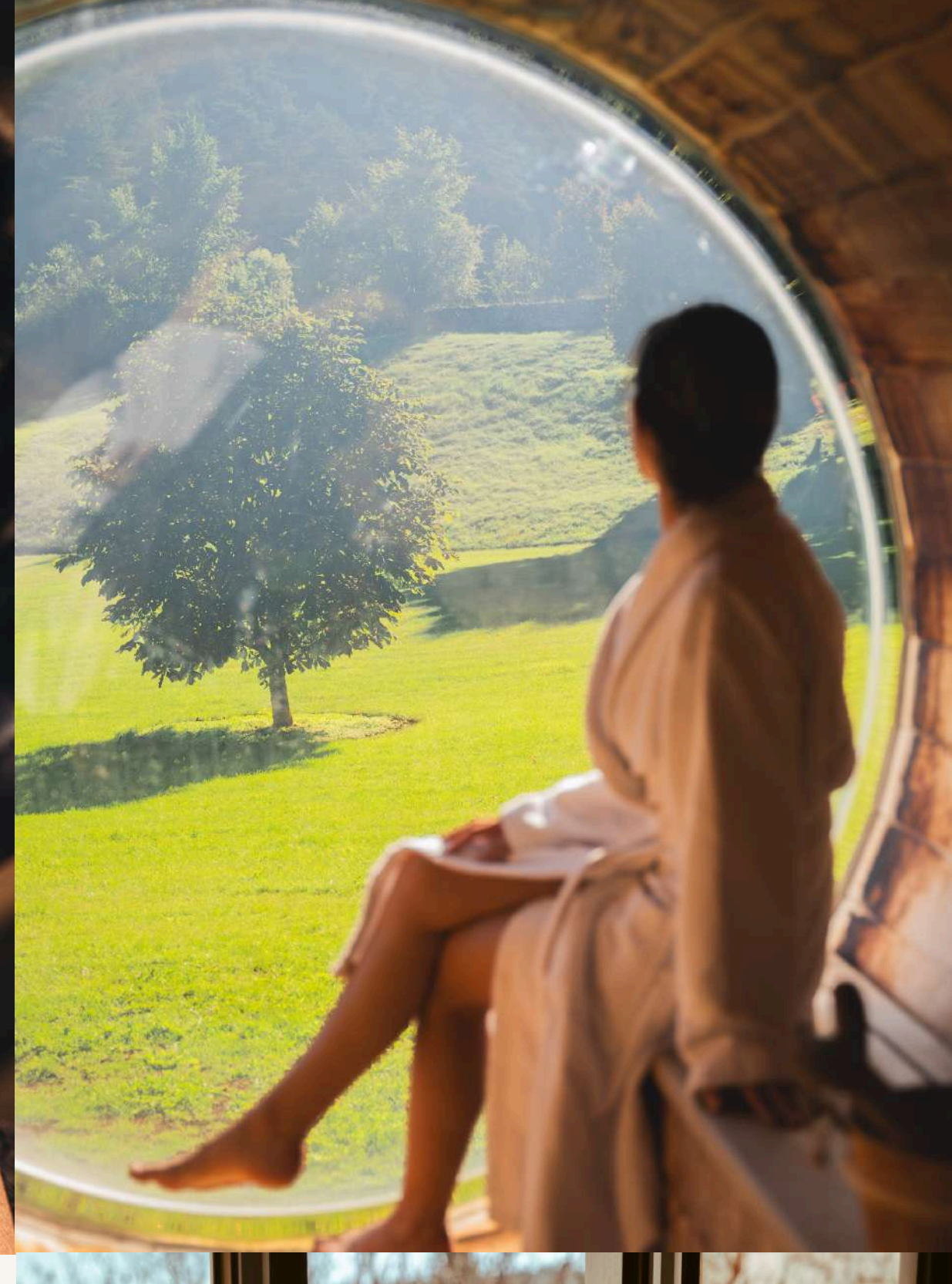
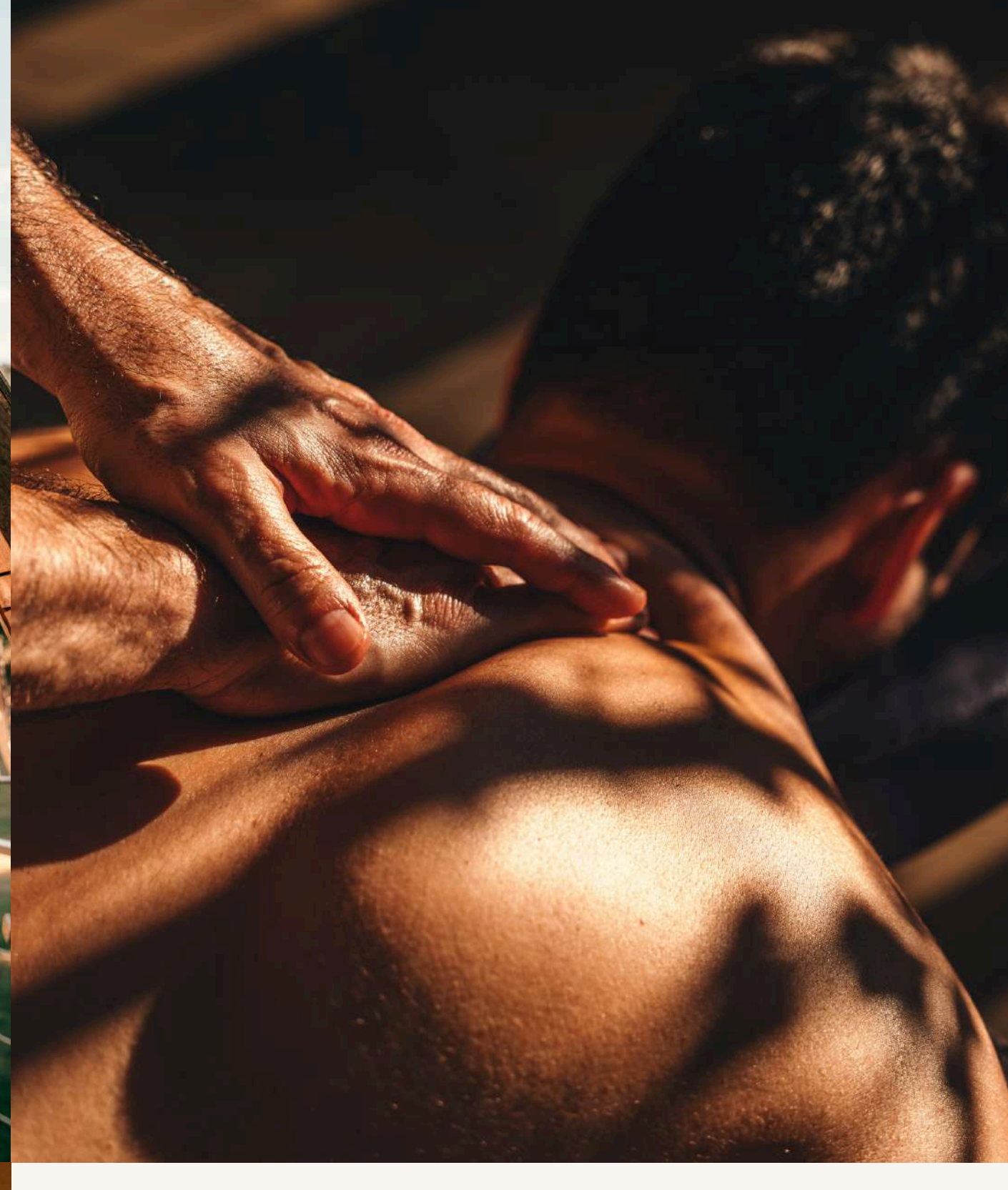
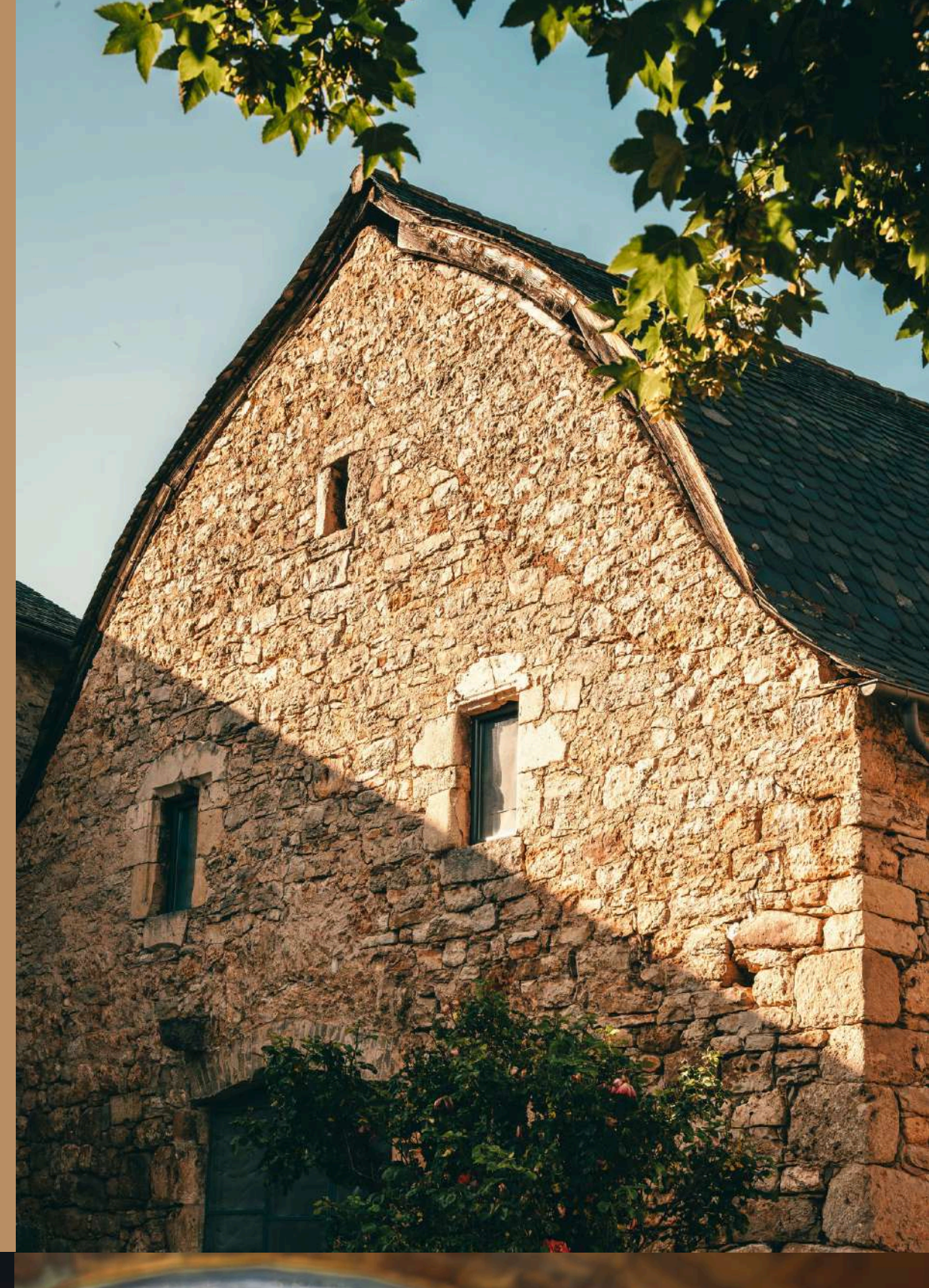

DOMAINE
DE LA *Vialette*



- . 3 hectares de parc naturel préservé
- . 5 chambres d'hôtes pour 12 couchages
- . 3 gîtes chaleureux pour 18 couchages
- . Table d'hôtes pour des repas authentiques

- . Four à pain à l'ancienne
- . Terrain de pétanque
- . Parking avec recharge électrique

- . Sauna bulle, bain nordique et bain froid
- . Grotte de sel et piscine intérieure chauffée
- . Massages à la carte



Expériences Signature* de La Vialette

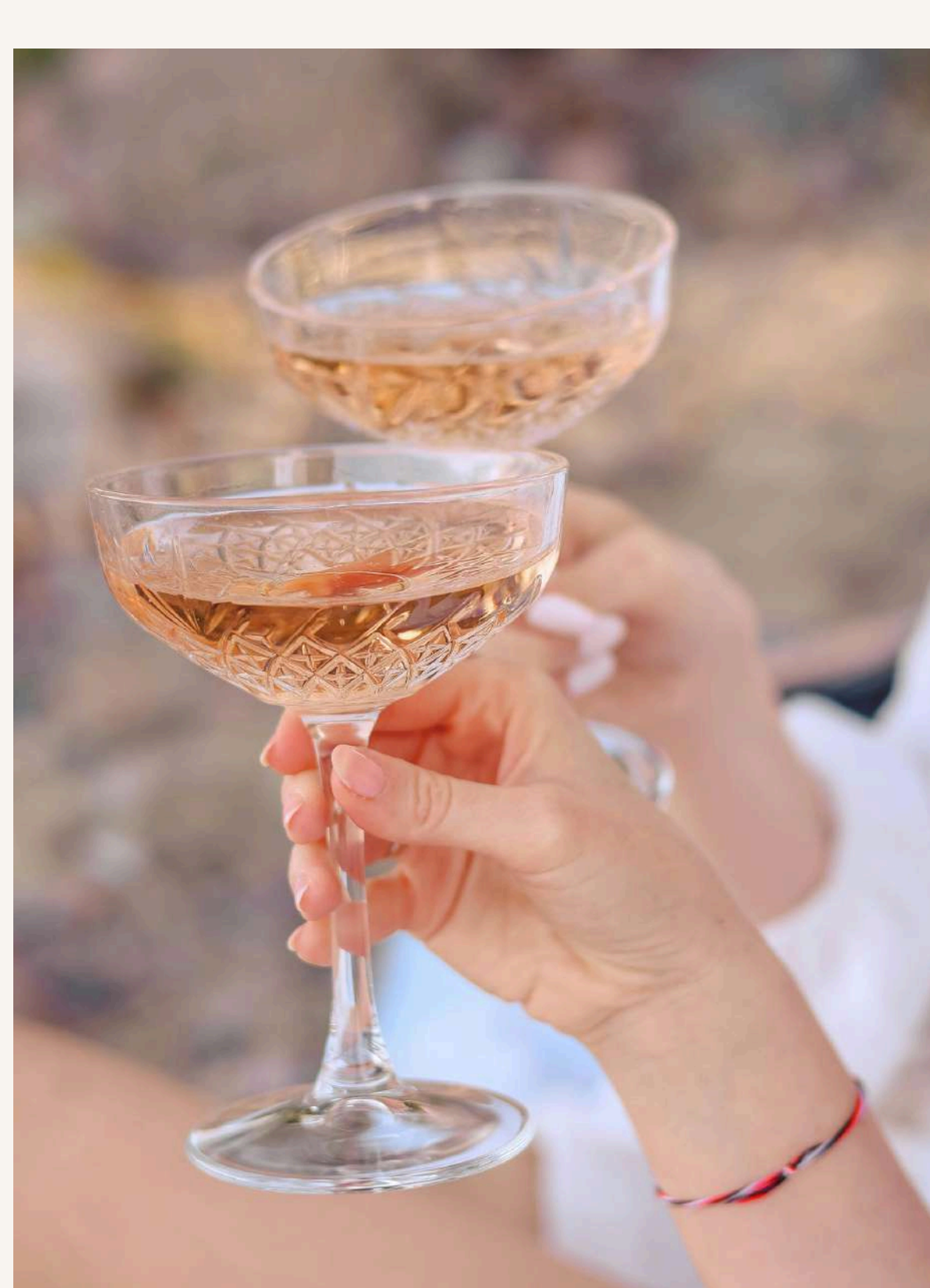

WELCOME PARTY La Veille

Une soirée de bienvenue
entre proches sous les étoiles.

Fêter vos retrouvailles en petit comité
sous le ciel de la Lozère. Au choix :
plancha et produits régionaux pour une
ambiance décontractée, ou cocktail
dînatoire imaginé par un traiteur local,
avec menu de saison sur mesure.

A partir de 50€ par personne
(30 personnes minimum)

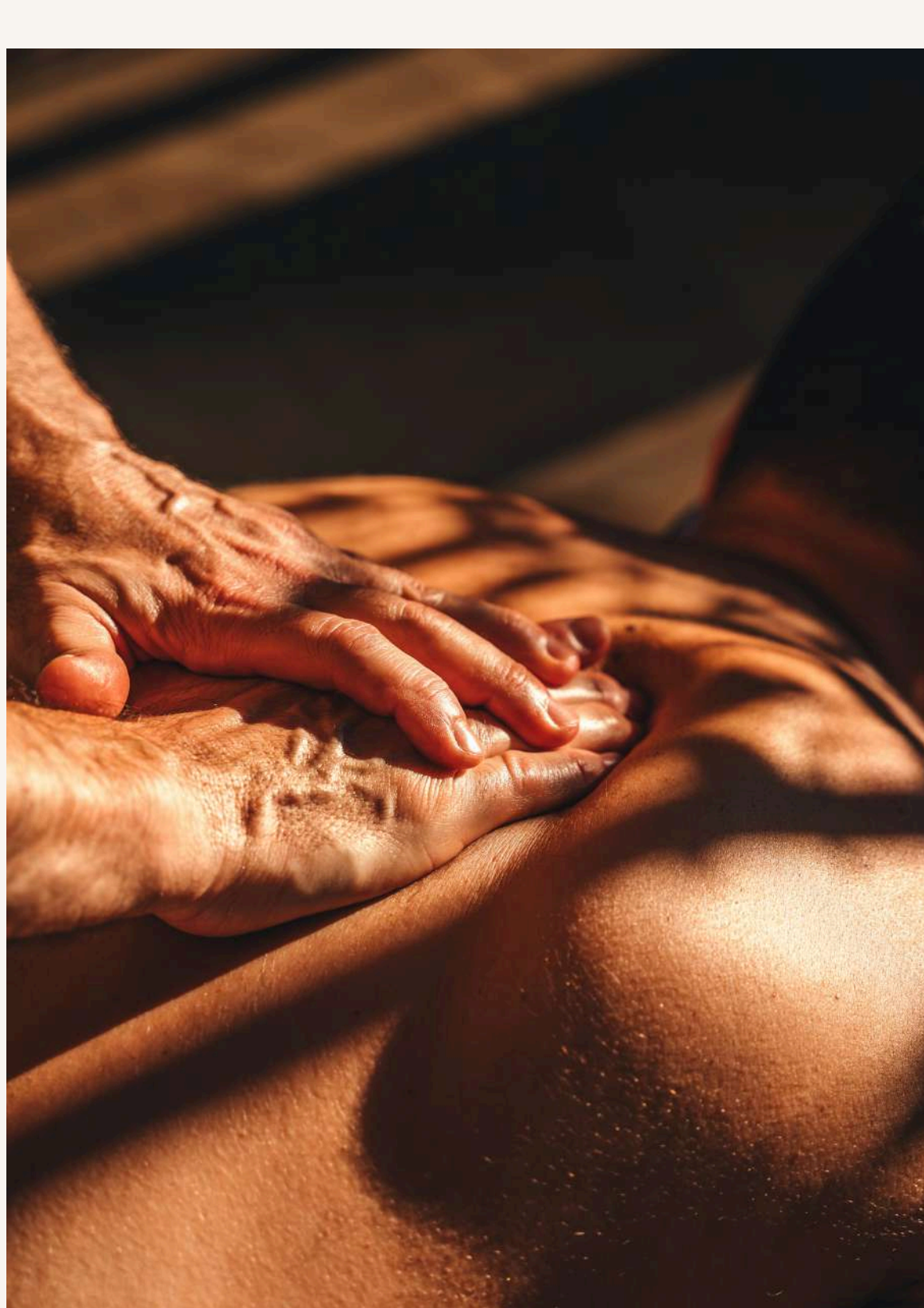

SPA MARIAGE Pendant le séjour

Un moment de douceur
avant le grand jour.

Faites une pause et chouchoutez-vous
avec notre sélection de soins La Vialette
pendant votre séjour. Pour les fiancés :
du Menu Spa Duo pour les invités, aux
massages de bienvenue pour les invités,
chacun y trouvera son équilibre.

A partir de 25€ par personne
(Massage à partir de 15 minutes)

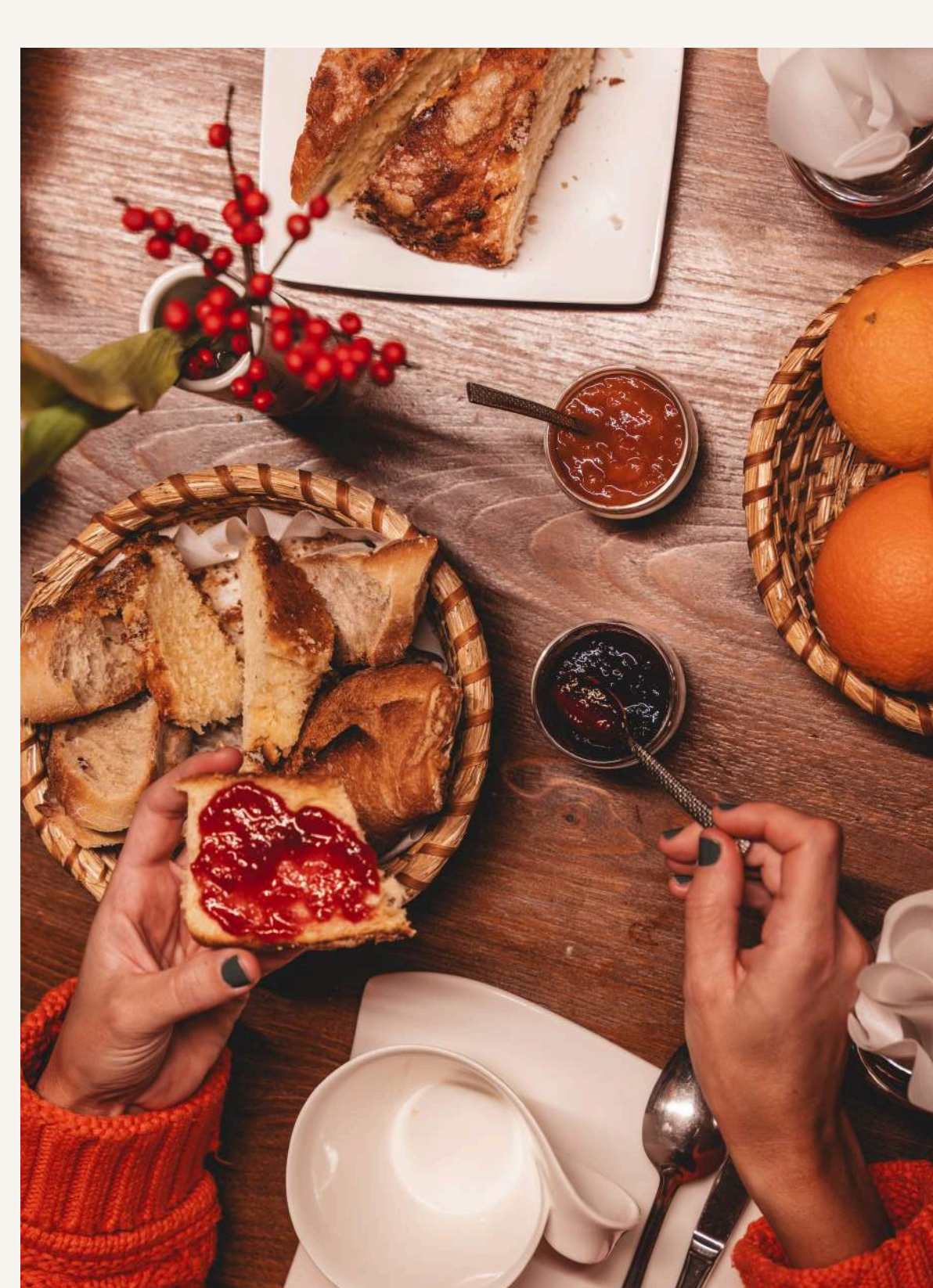

BRUNCH DE SAISON Le lendemain

Un ultime instant épicurien
à savourer avec vos proches.

Offrez-vous un instant gourmand avec
notre délicieux brunch sur mesure,
préparé par nos équipes et le boulanger
du village et servi au four à pain du
domaine ou près de la cheminée dans la
grande salle Cassenade.

A partir de 35€ par personne
(30 personnes minimum)

*Expériences Signature en supplément, sur mesure et sous réservation anticipée (tarifs HT susceptibles de modification sans préavis).



Maintenant...
Et si nous écrivions la suite ensemble ?



Cliquez et
Resentez l'Expérience!

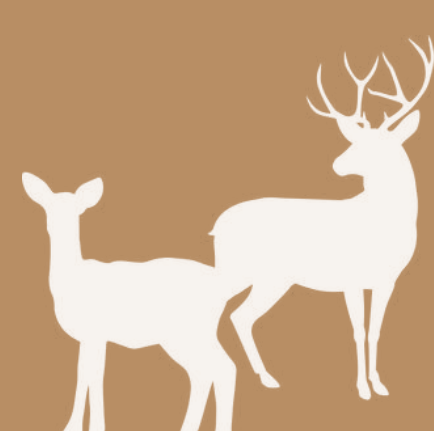

CONTACTEZ-NOUS!
Car chaque histoire commence
par une rencontre.

domaine.delavialette@gmail.com
WWW.DOMAINEDELAVIALETTE.COM



unveils its new space dedicated to weddings
in the South of France.

L'ORANGERIE
DE *Romy*

LOZÈRE - OCCITANIE



A place designed to host your most
meaningful moments.

Designed as a pavilion of light, L'Orangerie de Romy is the heart of your celebration. Bright and open to the 3 hectares park through large bay windows, it offers a refined, timeless, and fully modular space that can be tailored to your vision.

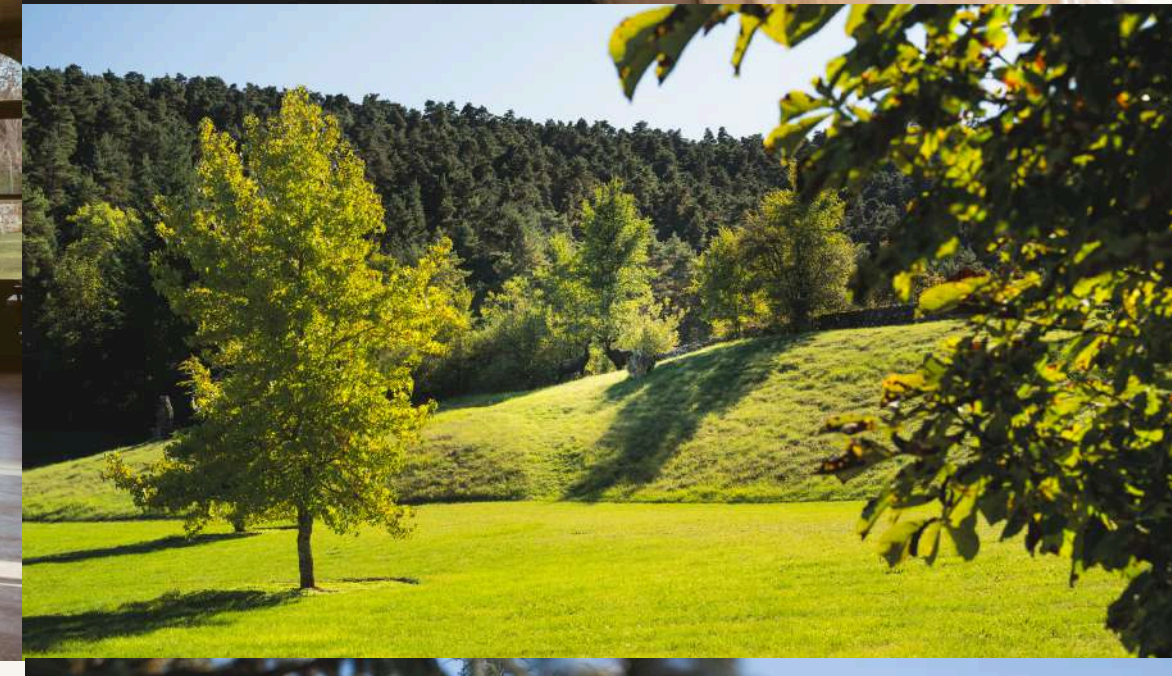
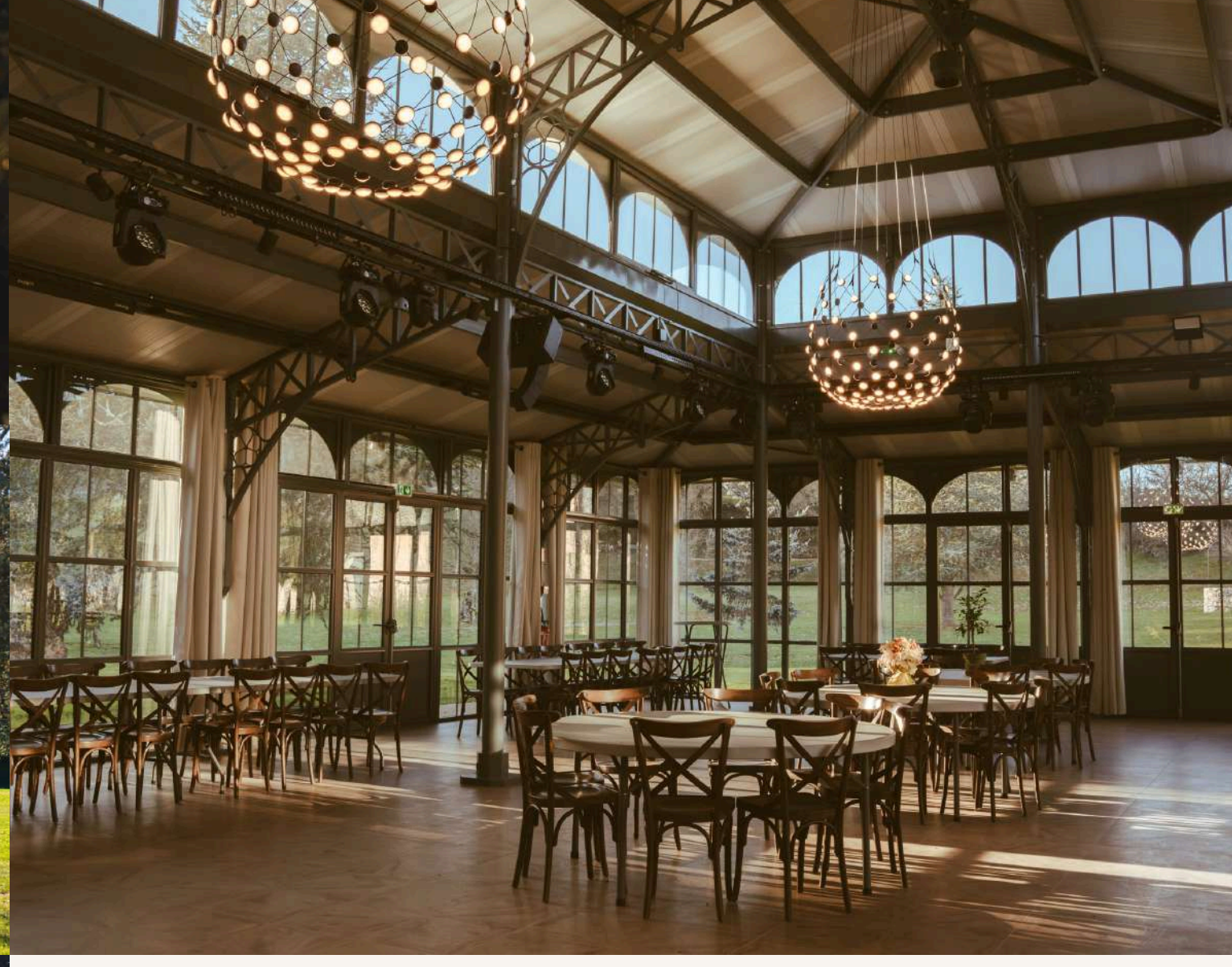

L'ORANGERIE DE *Romy*



Here, each union finds its own rhythm here.
The venue evolves with your vision, giving
life to a celebration that feels truly yours.

- Set within an exceptional 3-hectare natural park
- Reception capacity of up to 200 guests
- Integrated catering area, functional and discreet
- Modular furniture*
- Equipment on site: microphones, screen and projector
- Underfloor heating and cooling system
- Professional sound and lighting system

Whatever the season, L'Orangerie de Romy welcomes you to celebrate life in Occitanie, in complete freedom, within a natural and inspiring setting.

*Full list available in the brochure

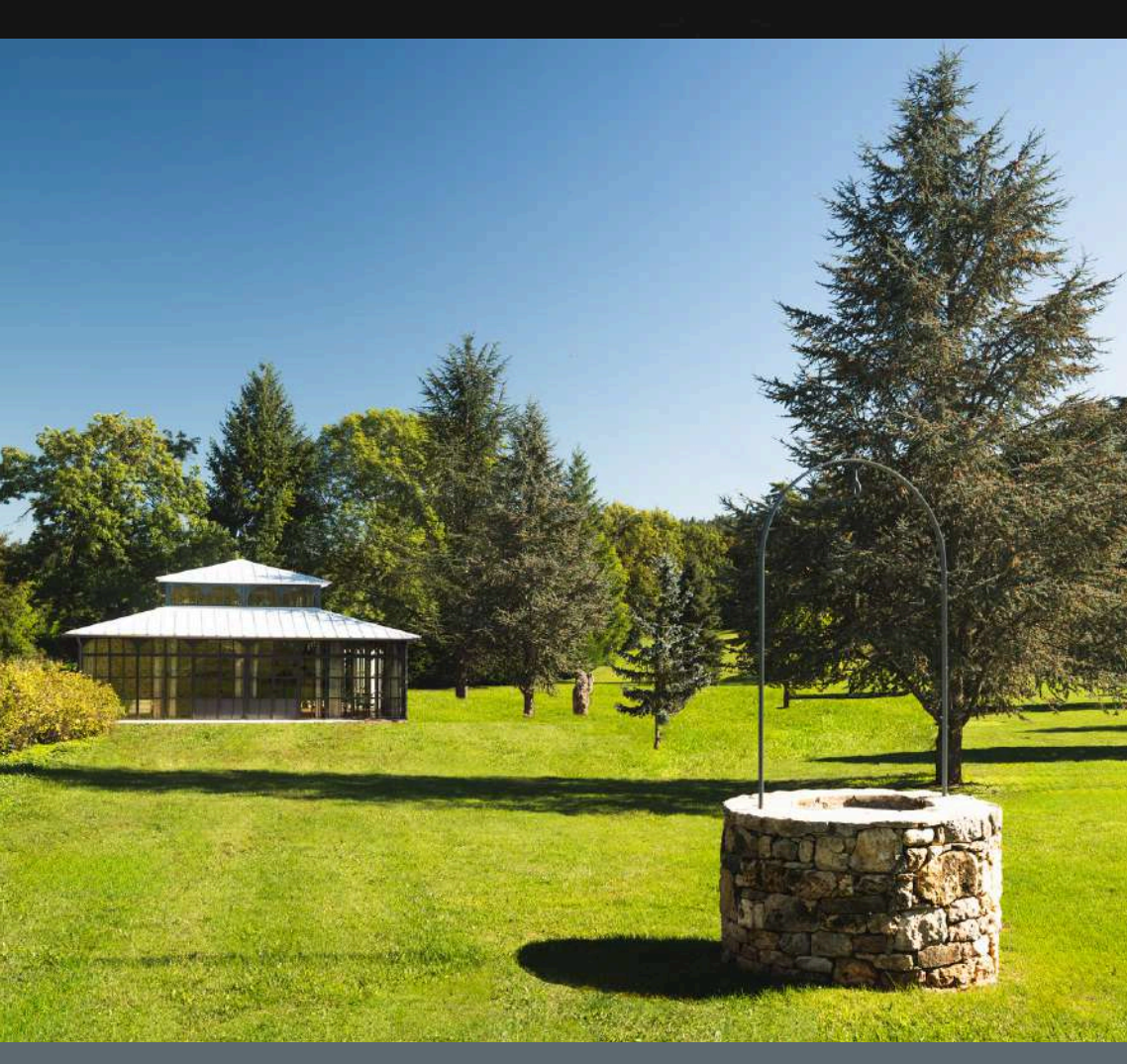

HIGH SEASON
From June to September

2 nights from 17 000€*
(3 nights from 19 500€*)

SIGNATURE EXPERIENCES
an add-on & subject to booking



LOW SEASON
March, from november to mid-december

2 nights from 13 000€*
(3 nights from 14 900€*)

SIGNATURE EXPERIENCES
an add-on & subject to booking



MIDDLE SEASON
April, May and October

2 nights from 15 000€*
(3 nights from 17 500€*)

SIGNATURE EXPERIENCES
an add-on & subject to booking



*Rates are subject to change without prior notice.

GENERAL CONDITIONS

YOUR WEDDING
at L'Orangerie de Romy

2026 RATES (INCL. VAT):

- Exclusive use of L'Orangerie de Romy and the outdoor spaces
- Modular furniture for 160 seatings
- Accommodation at Domaine de la Vialette (30 sleeping beds)
- Rates are subject to change without prior notice.

L'ORANGERIE DE ROMY

Access to the Orangerie from 10:00 am the day before your reception, until 4:00 pm the following day at the latest

CONDITIONS DE RESERVATION

- 30% deposit upon confirmation
- 30% three months before the event
- 40% one month before the event
- Deposits are non-refundable.

YOUR STAY
at Domaine de La Vialette

ACCOMMODATION & SERVICES

The privatization of the domaine include:

- 5 guest rooms and 3 cottages (sleeps up to 30 people on the domaine)
- French-style breakfast
- Wi-Fi access
- Access to the wellness area

CHECK-IN

- From 4:00 pm the day before your reception wedding

CHECK-OUT

- Rooms to be vacated by 12:00 noon the day after your reception wedding

SIGNATURE EXPERIENCES

Additional bespoke experiences are available upon request and advance booking. We invite you to discover them in our brochure.

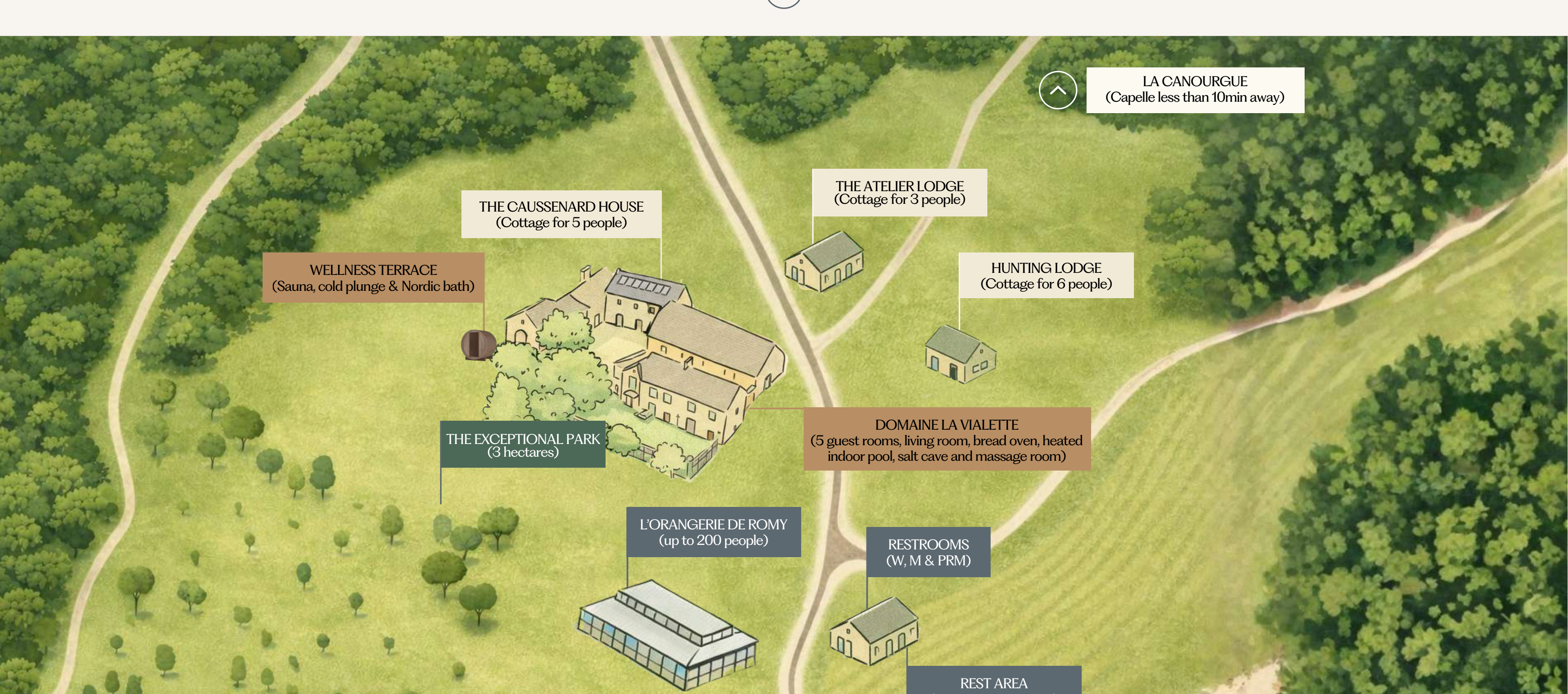

L'ORANGERIE DE *Romy*

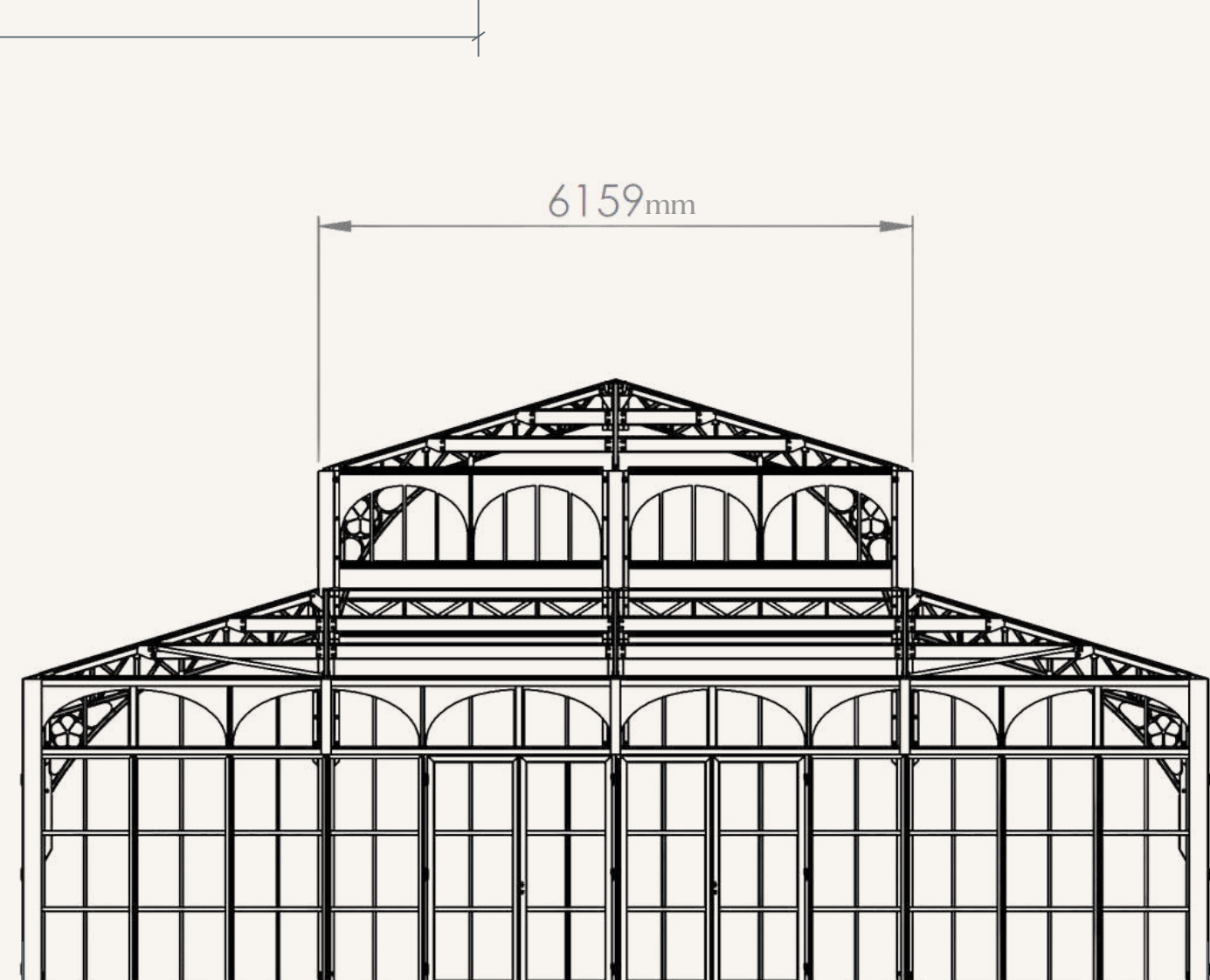
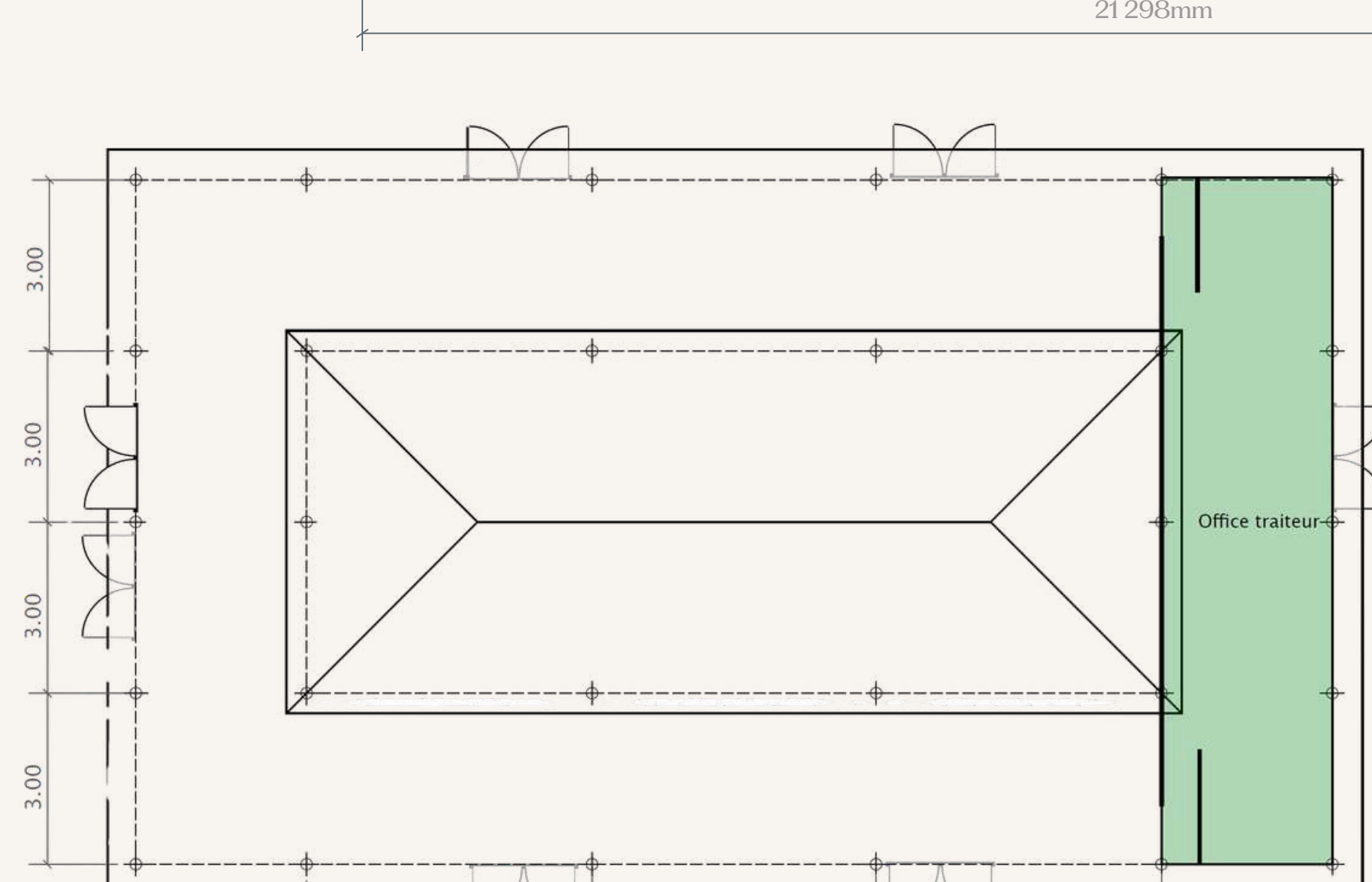
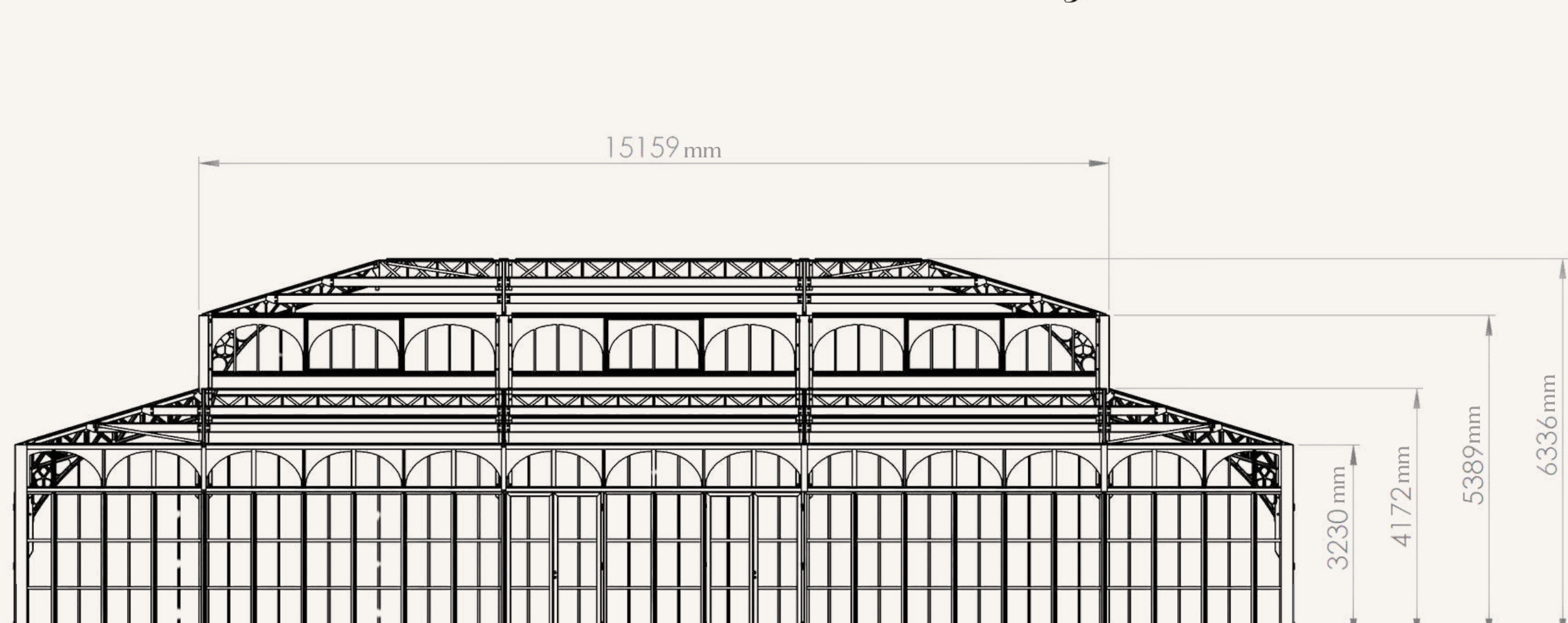

MODULAR FURNITURE
included in the rental



160 CHAIRS
Beech wood chairs



10 ROUND TABLES
For 8 people, 180cm



20 RECTANGULAR TABLES
Seats 8 to 10 people, 180x90cm



08 HIGH TABLES
80cm in diameter

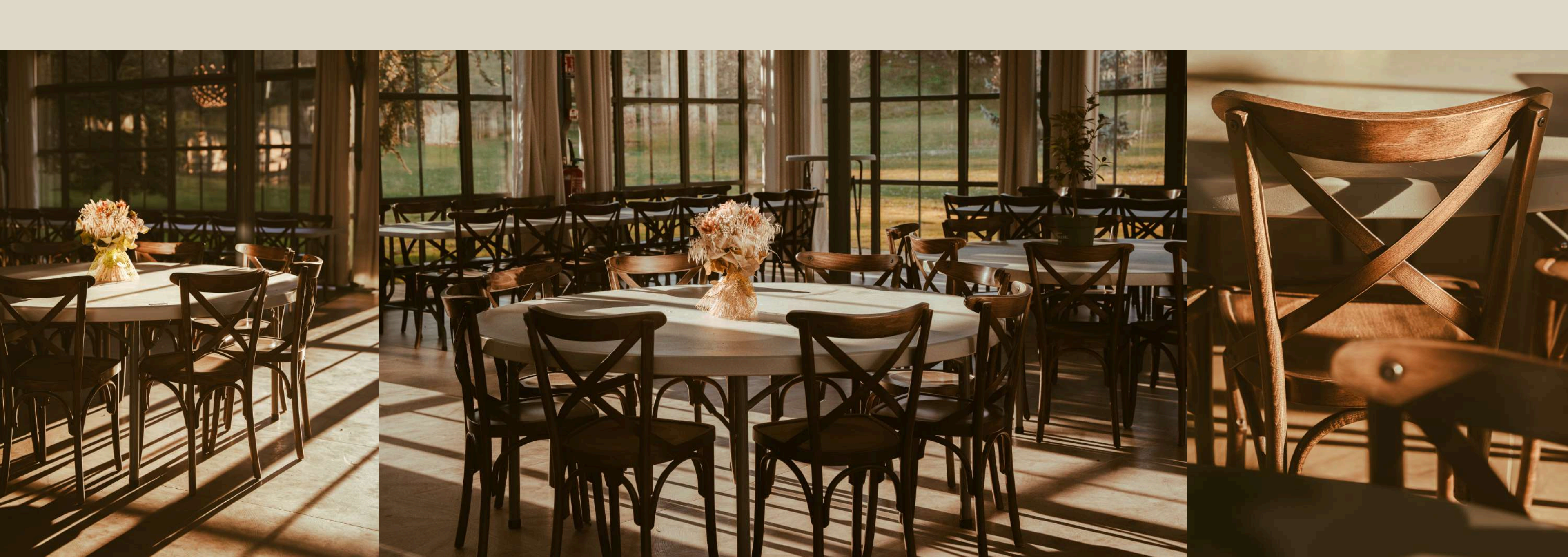

Your Ecologue in the South of France, in Occitania.



A cozy ecologue in the heart of exceptional natural surroundings.

Domaine de La Violette welcomes you in a natural and unspoilt setting

For over 42 years, this 14th-century farmhouse has been welcoming travellers seeking nature, tranquility and a true sense of authenticity



SLEEPS UP TO 30



WELLBEING AREA



TABLE D'HÔTES

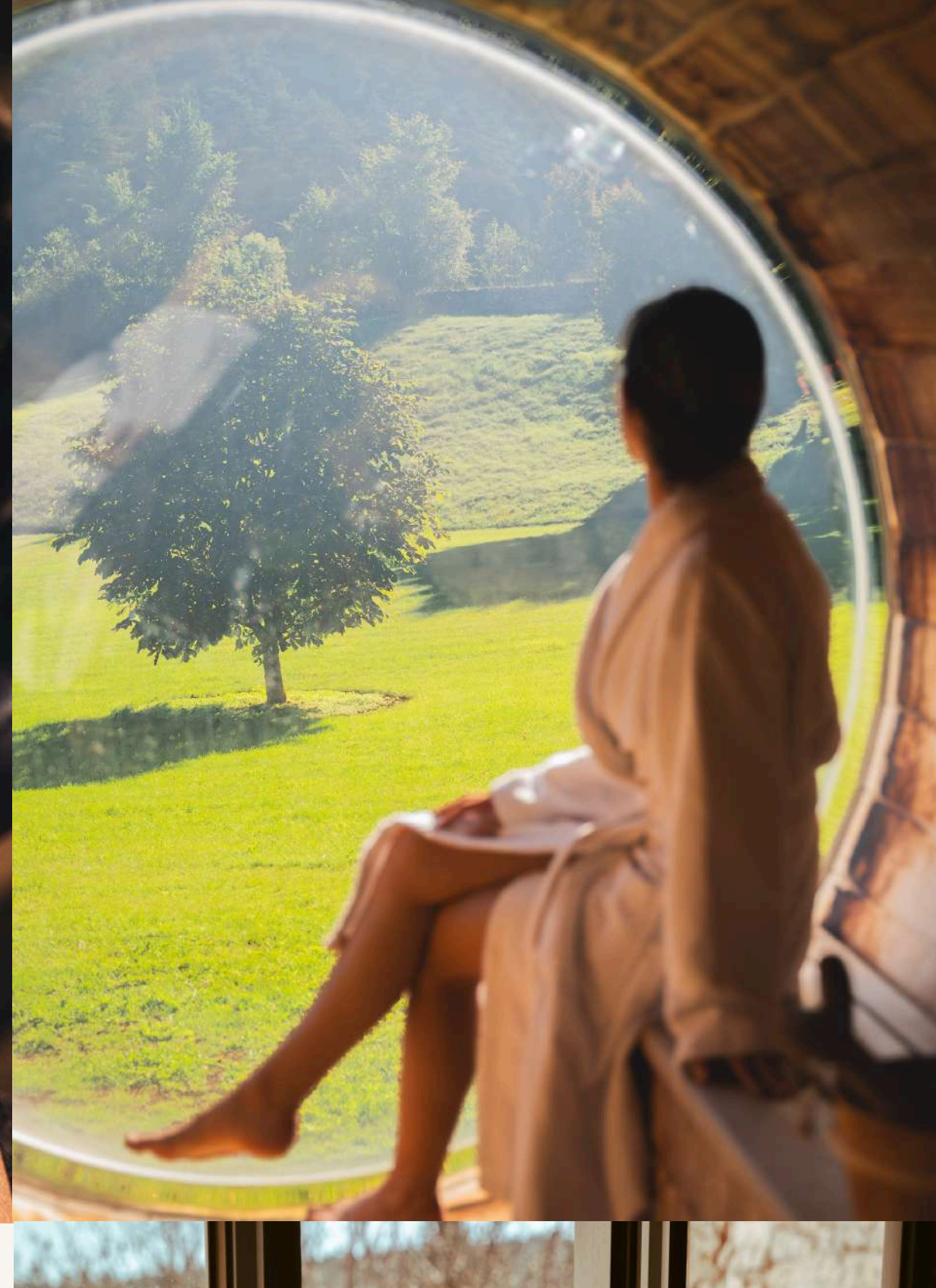
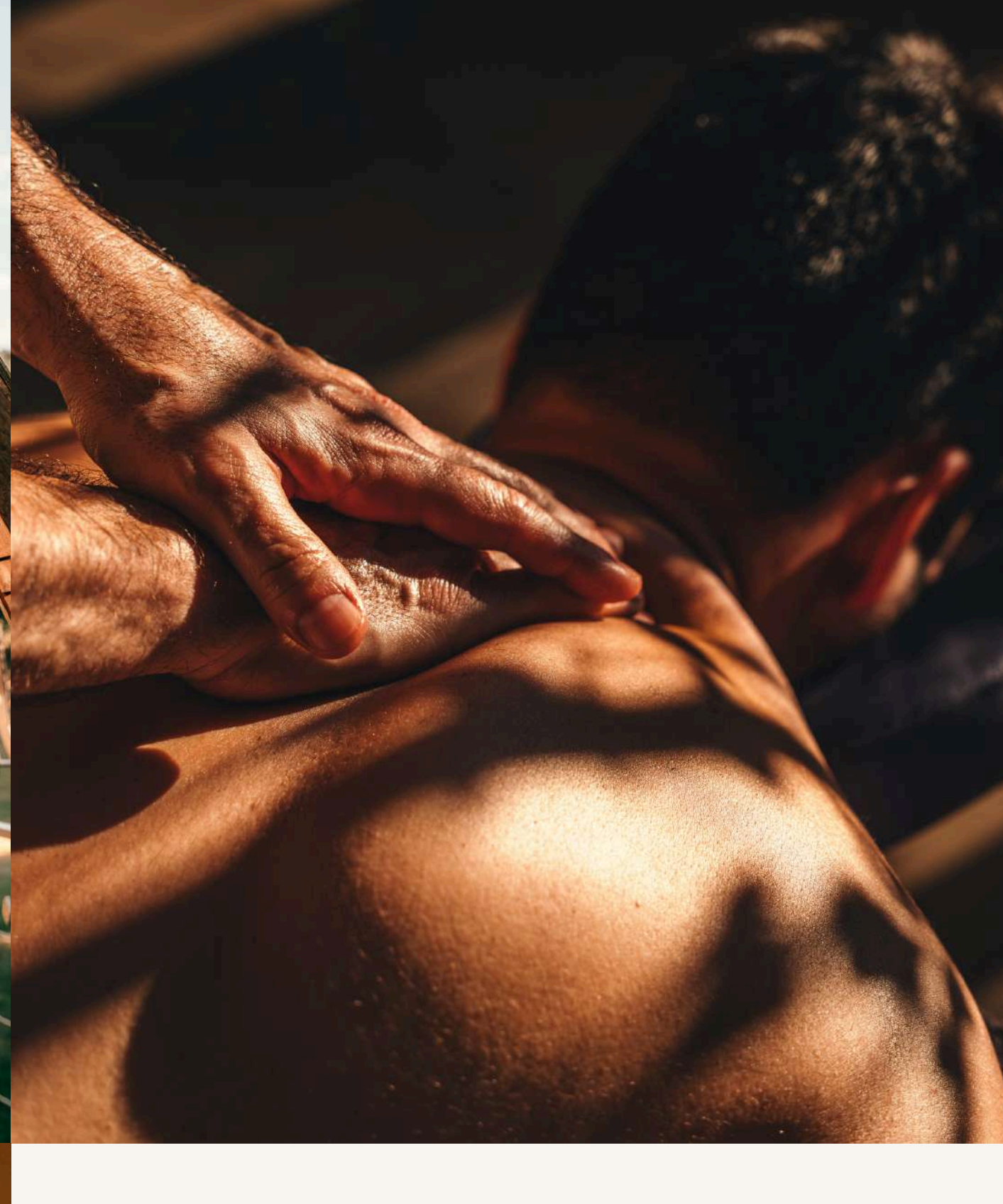
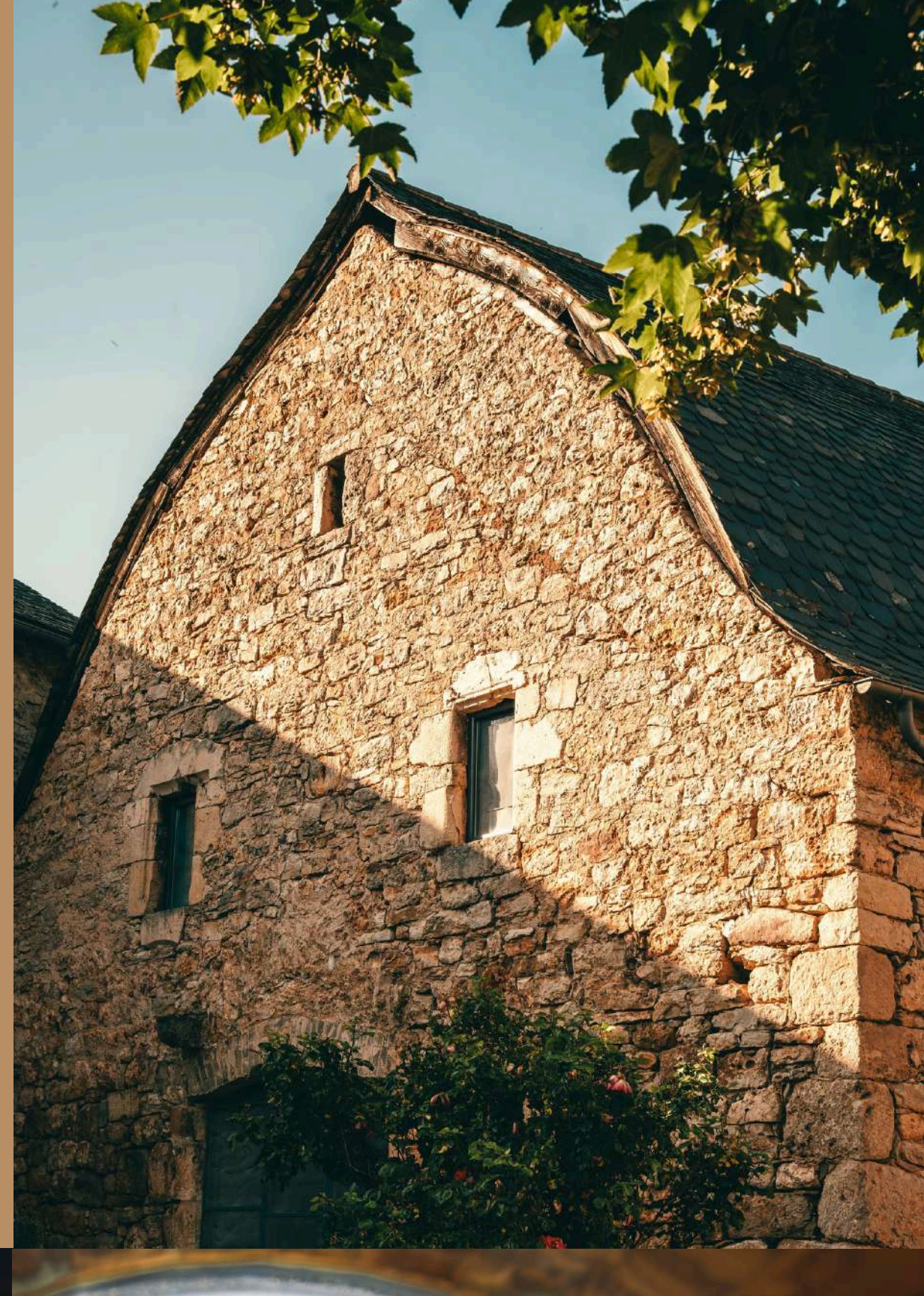

DOMAINE
DE LA *Violette*

- .3 hectares of nature at an altitude of 830m
- .5 guestrooms (beds for 12 to 14 people)
- .3 cottages (beds for 13 to 16 people)
- .Table d'hôtes for authentic meals
- .Traditional bread oven
- .Petanque court
- .Parking with electric vehicle charging
- .Barrel sauna, Nordic bath & cold plunge bath
- .Salt cave and heated indoor pool
- .Massages available



Signature Experiences* Tailor-made services

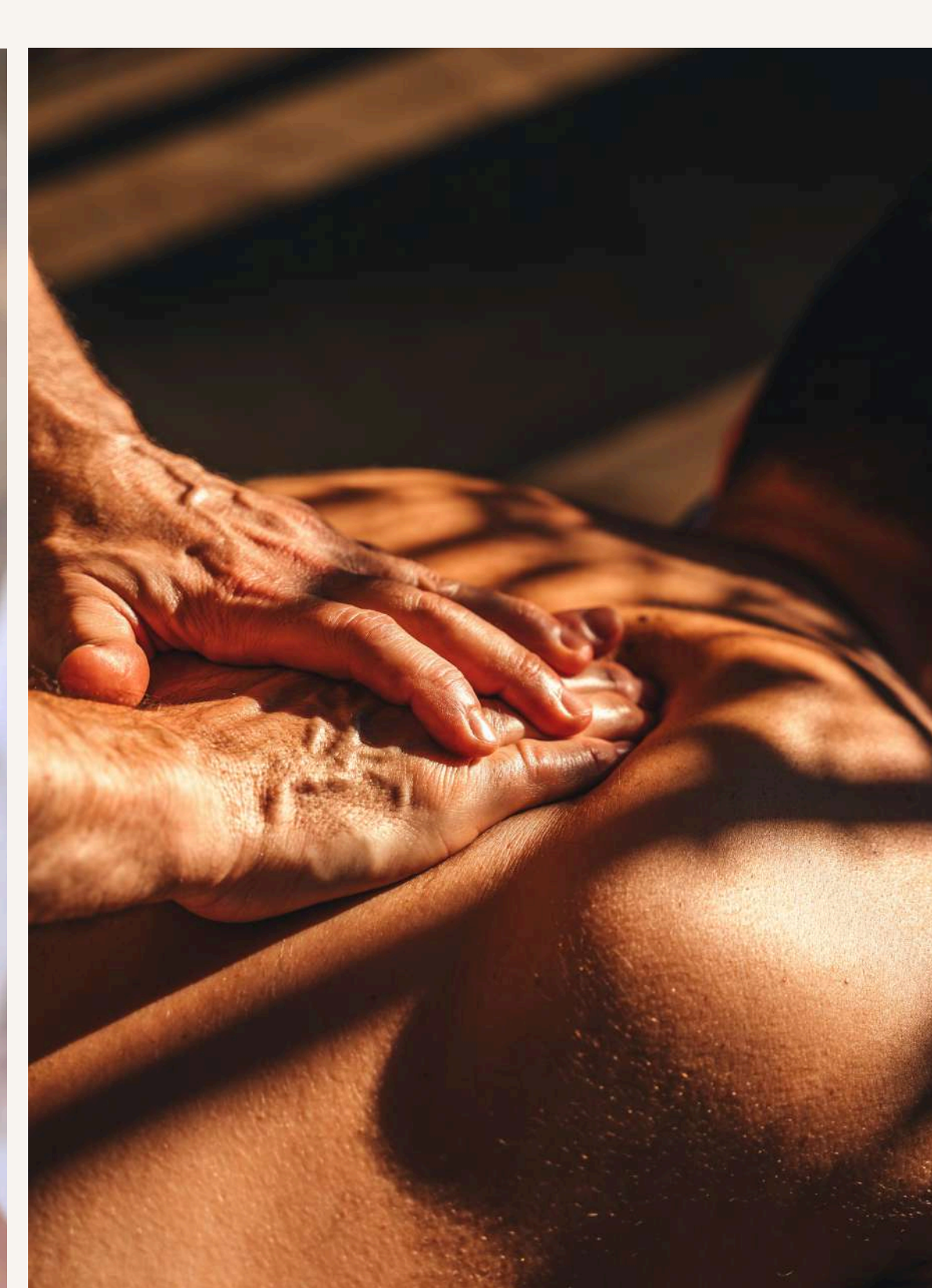
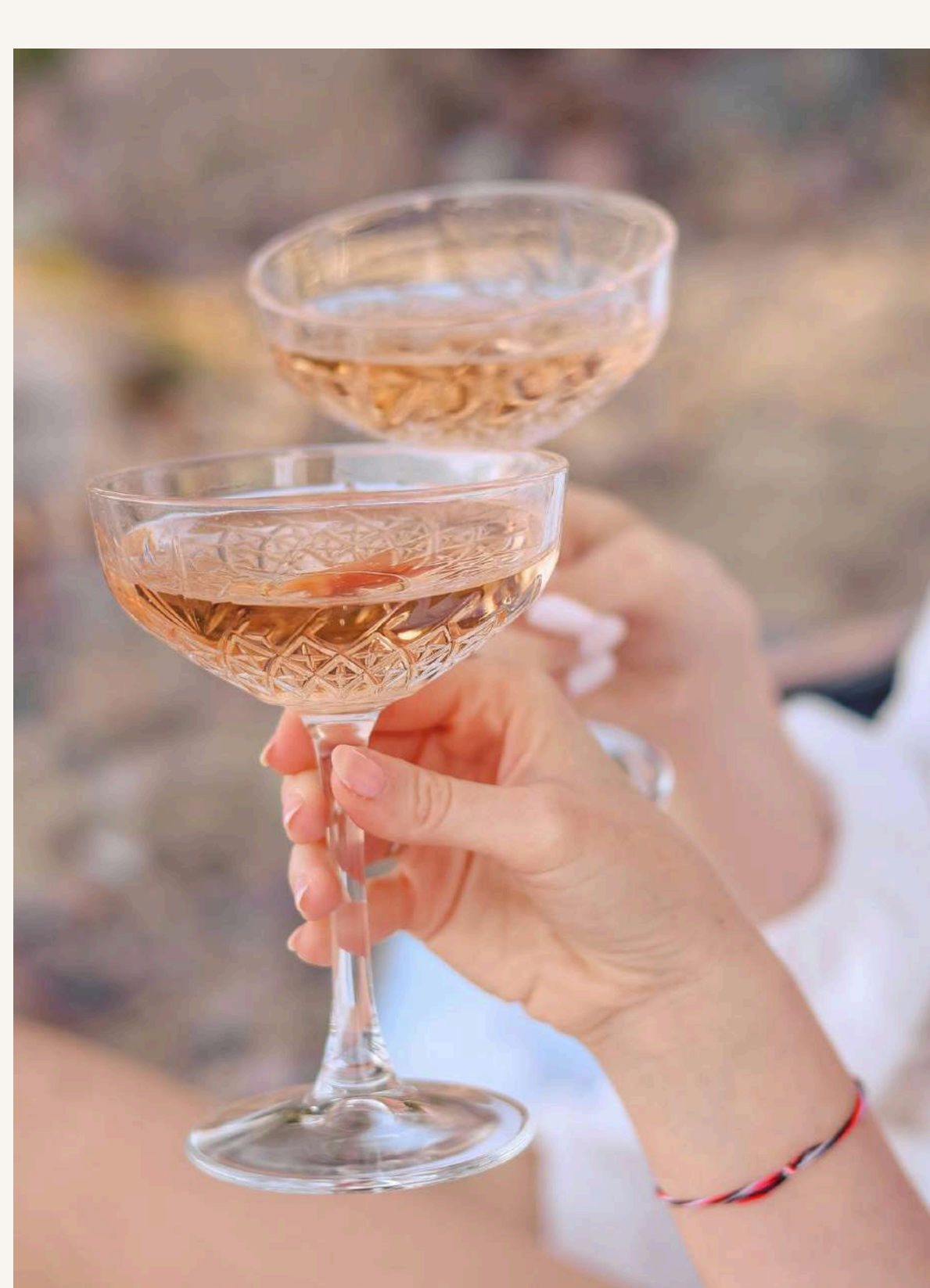

WELCOME PARTY
The day before

A welcome evening among friends under the stars.

Before the wedding, celebrate with your family and friends under the Lozère sky. Plancha grill with delicious regional products, or, a cocktail dinner with a bespoke seasonal menu, created by a trusted and local caterer.

From 50€ per person
(30 people minimum needed)

MENU SPA
During your stay

A moment of tranquility to recharge your energy.

During your stay, take a break and pamper yourself with our selection of treatments, designed exclusively for your event so that everyone can find their balance. From the Duo Spa Menu for couples to Welcome massages.

From 25€ per person
(Massage from 15 min)

SEASONAL BRUNCH
The next day

A final epicurean moment to savor with friends.

The next day, enjoy a gourmet moment with our delicious tailor-made brunch, prepared by our estate's bread oven or near the fireplace in the large Cassenarde room.

From 35€ per person
(30 people minimum needed)

*Signature Experiences are available as an add-on, tailor-made and subject to advance booking (prices are exclusive of VAT and subject to change without notice).



Now...
What if we wrote the next chapter together?

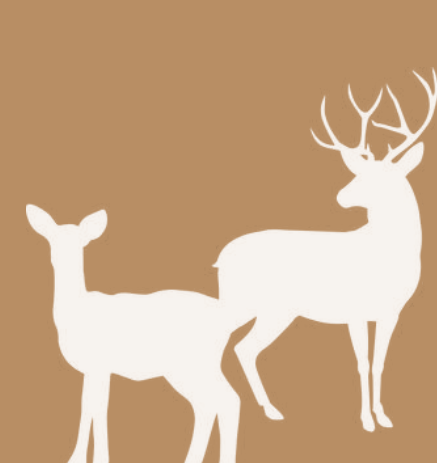
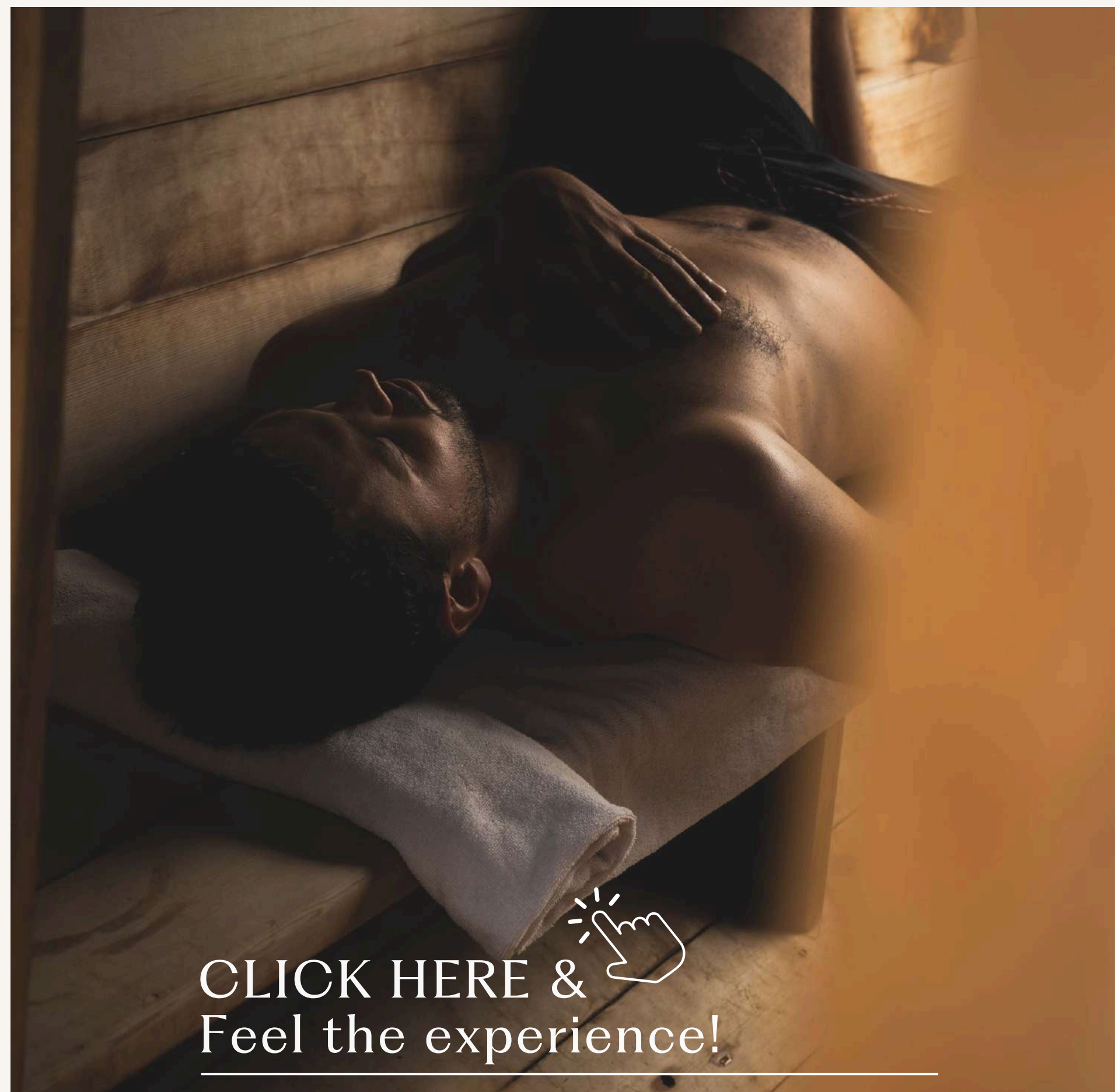

CONTACT US!
Because every story begins with an encounter.

domaine.delavialette@gmail.com
WWW.DOMAINEDELAVIALETTE.COM

